

19. MARCH. 2023

ATTENTION:

MR GARTH O'BRIEN K.C.
C/O 53 BANK STREET
TE AWAMUTU.

PH: 078717073 Mobil: 021891142

REF: ANTHONY BALLANTYNE D.O.B 19.3.1953
CLIENT
C/O HAUTU UNIT TONGARIRO PRISON.

RE: THE ANIMATION ENERGY INVENTION VIDEO
FORWARDED TO YOU BY ALAN WHICHMAN.

DEAR SIR: GARTH.

YOU HAVE MY FULL AUTHORITY TO FORWARD BY
E-MAIL A COPY OF MY INVENTION VIDEO. H.S.A.P.

TO: MR. WADE ARMSTRONG

§

KIND REGARDS.

ANTHONY "TONY" BALLANTYNE

§ Ballantyne

KINETIC ENERGY INVENTION

The Means For Facilitating The Supply Of Energy PCT/NZ2014/000051

Inventor Anthony Ballantyne

~~TRUE # NOT MISLEADING~~ J.P.

Patent invention & or Copy Right Design: must be Totally "Original" Unique, Never Before!

Invention: PCT/NZ2014/000051 (The means For Facilitating the Supply of Energy).

Natures Wonders: Most Powerful Forces: Hurricane, Cyclone, Tornado, Firer & Water Spout. All have "two" necessary actions in order to exist: Vortex Motion, & Pressure Zones "High & Low" (*Just Imajin harnessing the Power of any of these Natural wonders*).

I Did x 4 Cyclones! IN A NEW INFINITY DESIGN! Anthony Ballantyne (Inventor)

PCT/NZ2014/000051 Accepted (Passed Inspected & Objections) Published Date: 2n.10.2014.

"Original" Infinity Concept.

- **Oposing Vortex Rotational Forces, Southern & Northern Hemisphere opposing rotational Cyclones.**

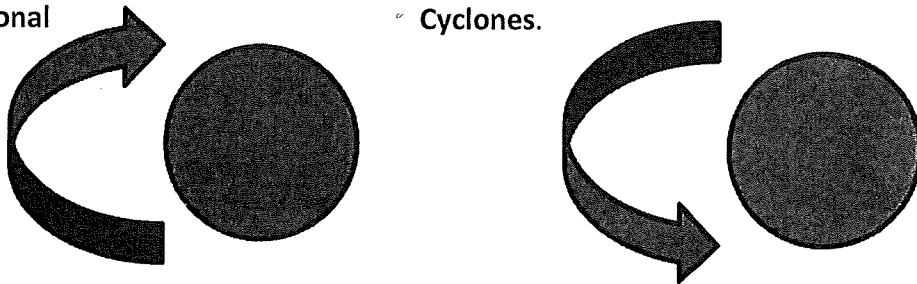

-
- **Facing together reciprocal rotation (Both an inner & outer Cyclone).**

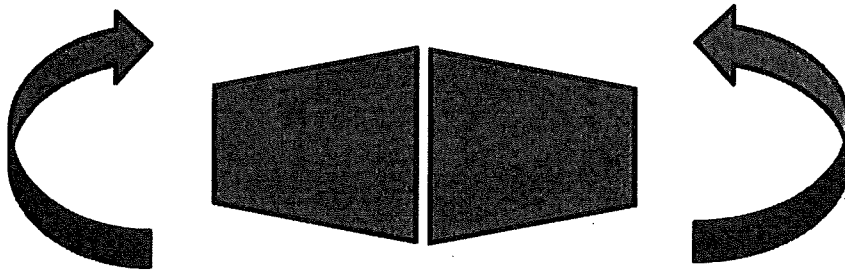

-
- **Inner into Outer.**

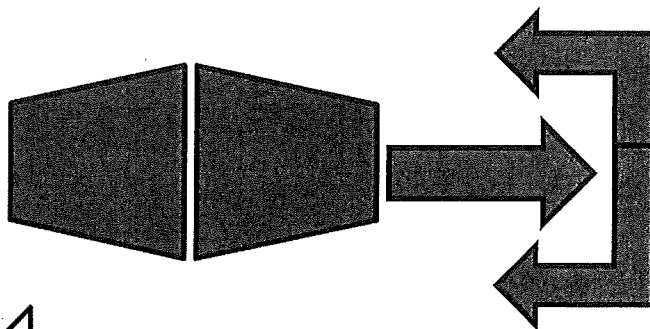

-
- **Outer**

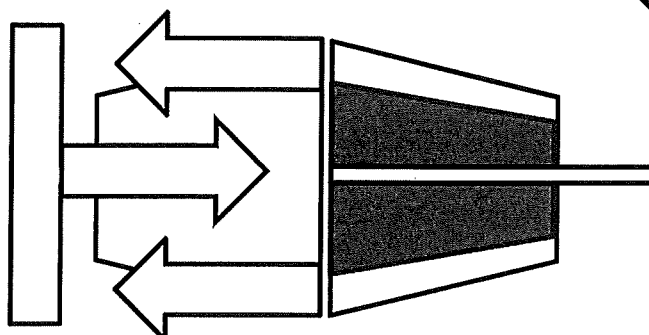

into inner.

Patent Countries Treaties Agreement X 192 Counties.

PCT/NZ2014/000051 NZ WO 2014/158031

Title: **Published in Geneva (2.October.2014)**

The Means for facilitating the supply of Energy.

NEW "GREEN ENERGY" TECHNOLOGY INVENTION!

30 years in the making. **Peer Reviewed & Authenticated (28.10.2014) A. U.**

Science: Physic's Laws.

Chaos Theory: Vortex Motion, Order from Chaos.

Ergodic Theory: Multiple Body motions: Solid Mass, H₂O.

Brownian Theory: Random Motion, of Molecules'.

Bernallie Theory: Pressure Zones in Air & Fluid.

Mass X Velocity: Exponential Motion, Laminar flow, Friction free.

One size fits all.

Operates: vibration free, In Vertical, Horizontal, forward and or reverse Motion, able to operate in the deepest oceans or the highest mountains.

Stage One: No Fossil Fuel Required, Provides more Mechanical Kinetic energy "OUT" than input.

Stages One, Two, Three, Four,

Application's: GLOBAL

Able to intergrade with-in the worlds existing technology to allow a peaceful transition over time.

To become the world's dominate energy provider, in less than a decade enabling a reversal to Global Warming.

One of many future World changing Inventions, by Inventor Anthony "Tony" Ballantyne. (Antonym Technologies)!!

Figure 4

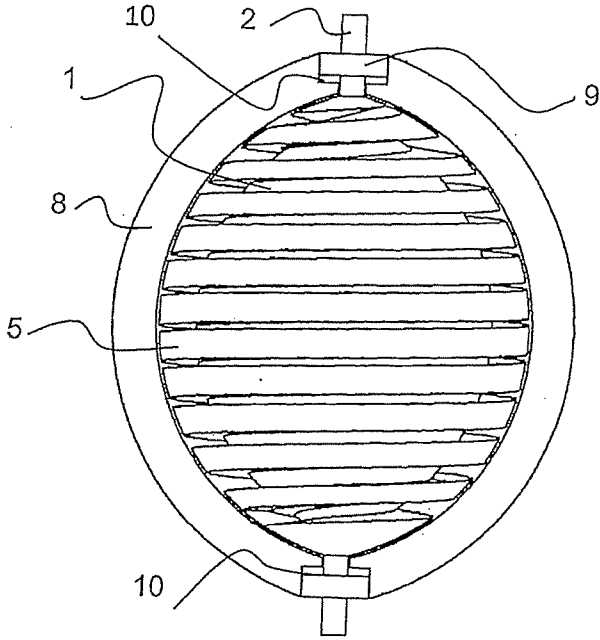
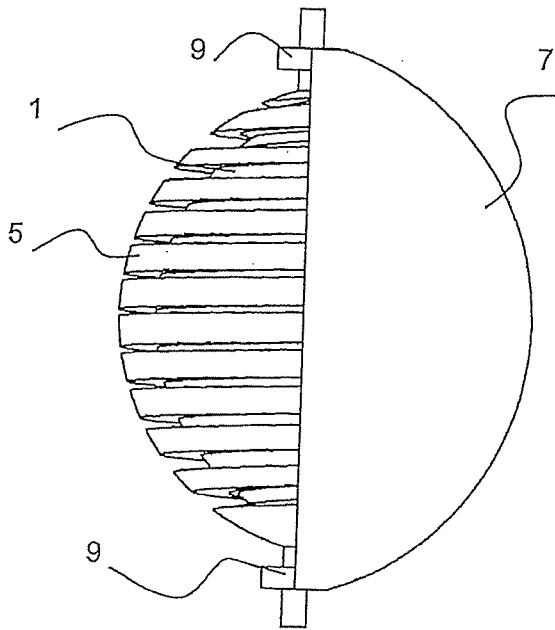

Figure 5



Handwritten signature and initials

Ref: **Mr. Marc Millis** (*NASA Space Propulsion Technology Division*).

POSTLATE (WARP SPEED) Hypothetical!!

Based on the idea of an inflationary Universe & belief that during the first moments of the big bang Space Time expansion is faster than the speed of light, warp drive is an approach that would circumvent the speed of light limit imposed on matter by relativity.

In space time can streak faster than the speed of light, **WHY NOT** a space ship powered by an engine that would work by moving space around the matter, space may be nonmaterial, and such a ship could travel faster than the speed of light & would be propelled weightlessly through space time!

How to contract space-time in front of your ship % expand space time behind your ship, this warp space & region with-in would propel itself “with your ship” at an arbitrary large speed & those inside would feel **NO** acceleration force as they zip along at **WARP SPEED**.

Example, Gravity Waves is both positive and negative, Electromagnetic waves!

To design an engine that creates a continues streak of electromagnetic energy wave force, causing the positive on coming space-time expanding gravity waves are **PULLED** towards your frontally negative charged craft, propelling that craft forward at the same time as your positive charged rear electromagnetic wave charge is **PUSHED** away from the negative gravity charged waves! (Warp Speed)!

IS THIS HYPOTHESIS POSSIBLE? YES!!!

1. B. 1 of 4 Copy

CONFIDENTIALITY AND NONDISCLOSURE AGREEMENT

THE PARTIES:

This agreement is between

TONY BALLANTYNE, of 202 Acadelles Ave Waiwanga
Bellamy (hereinafter referred to as "Disclosing Party")

and

AUCKLAND UNISERVICES LIMITED, a company organised under the Laws of New Zealand, having its registered office at Level 10, UniServices House, 70 Symonds Street, Auckland, New Zealand (hereinafter referred to as "Recipient").

WHEREAS:

The Parties wish to discuss confidential business and technical information of the Disclosing Party relating to an *exponential or vortexual motion machine* (the "Invention") so that they can discuss intellectual property strategy, whether to investigate the invention further, and/or bring the invention to the Return on Science investment committee. These discussions require the disclosure of confidential and/or proprietary information of the Disclosing Party to the Recipient.

THE PARTIES AGREE AS FOLLOWS:

Definitions and Interpretations:

1. "Confidential Information" shall mean any and all information of the Disclosing Party in or relating to the invention, whether scientific, technical, trade, business or information of any kind, which is treated by the Disclosing Party as confidential, whether or not that information is labeled or stated to be confidential, subject to the proviso below. Without limitation, this information includes techniques, formulations, equipment, tests, data, text, reports, compilations, tables, drawings, sketches, know-how, sources of supply, patent position, relationships with consultants and employees, business plans and business developments, information concerning the scope or activities of research, development, manufacturing, marketing or other projects, samples and materials.

Providing that "Confidential Information" does not include information:

- a. already in the public domain prior to the date of disclosure by the Disclosing Party; or
- b. demonstrated from written records to have been in the Recipient's possession from another source, not under obligation of secrecy to the Disclosing Party, prior to disclosure by the Disclosing Party; or
- c. that subsequently becomes part of the public domain through no fault of the Recipient; or
- d. independently developed by the Recipient, as evidenced by written records, without the use of the Disclosing Party's Confidential Information.

Permitted Use

2. Confidential Information disclosed by the Disclosing Party to the Recipient may be used solely for the purpose of determining whether it is desirable to enter into a collaborative business relationship with the Disclosing Party, and for no other purpose.

Acknowledgment Regarding Proprietary Rights

3. The Recipient acknowledges that any and all proprietary rights in Confidential Information of the Disclosing Party belong to the Disclosing Party.

Nondisclosure of Confidential Information

4. Subject to clause 7 below, the Recipient shall not directly or indirectly publish, disseminate or otherwise disclose, deliver or make available to any third party (including subsidiaries, associated companies, joint venture parties or other associated organisations) any of the Confidential Information without the written consent of the Disclosing Party. Any disclosure to any third party, with consent, shall only be made under a written agreement with terms equivalent to those in this agreement.

5. The Recipient may only make Confidential Information available to its employees on a need to know basis. All such employees shall be made fully aware of the confidential nature of the information and shall sign a formal agreement with terms equivalent to those in this agreement.

6. The Recipient shall be liable for any breach of confidentiality by its employees.

7. A receiving party shall be entitled to disclose Confidential Information to the extent required by any applicable law, or by any judicial, Governmental or other official order, decree, regulation or rule, but only after written notification to the disclosing party of the requirement to do so specifying what Confidential Information is required to be disclosed, and to whom; and the receiving party shall take all reasonable steps necessary to ensure that any opportunity to challenge disclosure is preserved for the owner of the Confidential Information.

Duration

8. The obligations of confidentiality and non-use in this Agreement shall be binding throughout the term of this Agreement and shall remain in force for a period of five (5) years from the date of its expiration or termination.

Miscellaneous

9. Confidential information shall always be retained in a secure environment.

10. Upon termination of this agreement, the Recipient shall promptly, and within 5 working days, return to the Disclosing Party all originals and any copies of Confidential Information, and shall permanently delete all electronically or otherwise stored Confidential Information from all systems containing such Confidential Information, except that one copy may be retained solely as a measure of the Recipient's obligations hereunder.

11. The Disclosing Party warrants that it has the right to disclose any information that is disclosed under this Agreement.

12. The Disclosing Party gives no warranty, either express or implied, to the Recipient that any information disclosed:

- (a) is completely accurate; and/or
- (b) is useful in terms of this Agreement.

13. Any notice given under this agreement shall be in writing and shall be delivered in person, by courier service, by facsimile (provided that the sender's facsimile machine confirms transmission to the intended recipient), or by email (provided that the sender receives by email from the recipient, in the form of a return email or automatic confirmation message, confirmation of transmission to the intended recipient) addressed to the parties as follows:

If to the Disclosing Party, to:

Contact: _____
 Address: _____

 Fax: _____

If to the Recipient, to:

Contact: Will Charles
 Address: Auckland UniServices Limited
 Level 10, UniServices House
 70 Symonds Street
 Auckland
 New Zealand
 Fax: 0064 9 373 7412

14. The Recipient acknowledges that monetary damages alone may be an inadequate remedy for breach of the Recipient's obligations under this Agreement. In addition to any other remedy which may be available in law or equity, the Recipient agrees that the Disclosing Party shall be entitled to interlocutory injunctive relief to prevent any breach of this agreement.

15. This Agreement may not be amended, modified or revised except by a written instrument signed by an authorised representative of each party.

16. Nothing in this agreement shall be deemed to constitute, by implication or otherwise, the grant to the Recipient of any license or other interest in any proprietary rights of the Disclosing Party.

17. This Agreement shall not be assignable by either party without the written consent of the other party.

18. This Agreement shall be construed in accordance with the Laws of New Zealand and subject to New Zealand jurisdiction.

19. Should any provision of this Agreement be held by a Court to be unlawful, invalid, unenforceable or in conflict with any rule of law, statute, ordinance or regulation, the validity and enforceability of the remaining provisions shall not be thereby affected.

20. This Agreement is effective for a period of twelve (12) months from the date of execution of this agreement. The obligations of confidentiality and non-use survive expiration and termination.

21. This Agreement may be executed in two or more counterparts, each of which shall be deemed an original, but all of which together shall constitute one and the same instrument, as of the date first above written. Facsimile signatures shall have the same effect as original signatures.

Dated this 21st day of October 2014

IN WITNESS WHEREOF, the parties have executed this Agreement as of this day and year.

Executed by

TONY BALLANTYNE

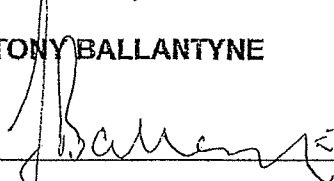

in the presence of:

Witness: Megan Hyland
Name: Megan Hyland
Address: 27 Potllock Dr
Chartwell
Hamilton

Executed for and on behalf of

AUCKLAND UNISERVICES LIMITED
by authorised officer

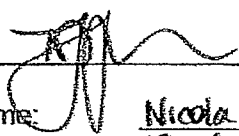

Name: Nicola Johnstone
Capacity: IP Advisor

in the presence of:

Witness: Evelyn Boyd
Name: EVELYN BOYD
Address: AUCKLAND.



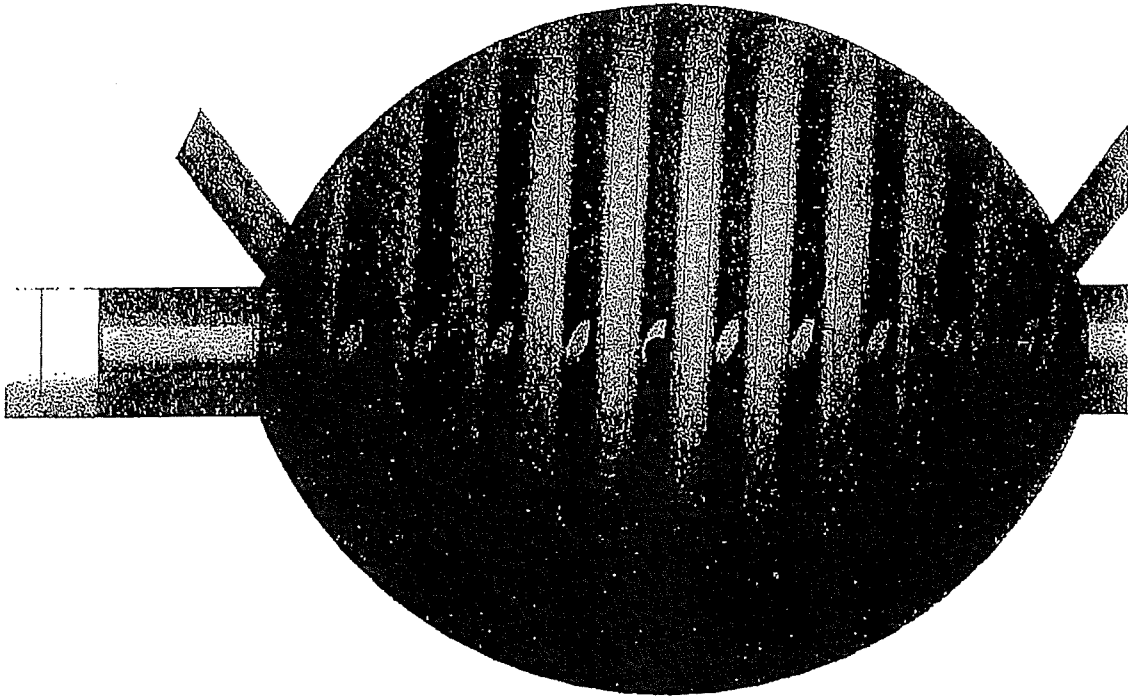

5

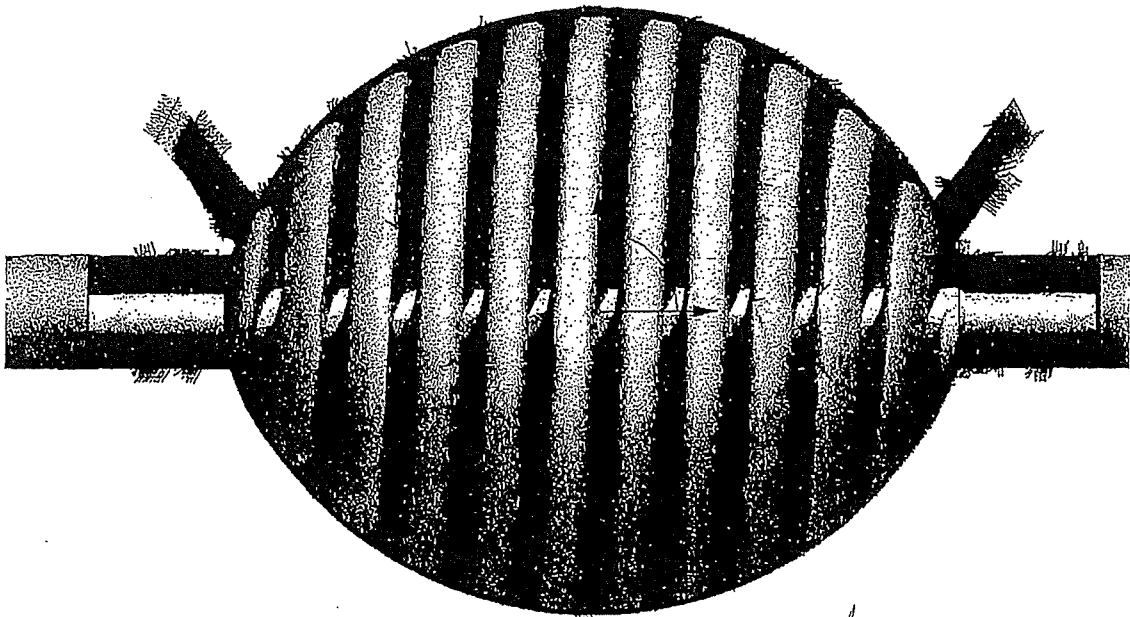

6

F. B. Nantye
copy Right

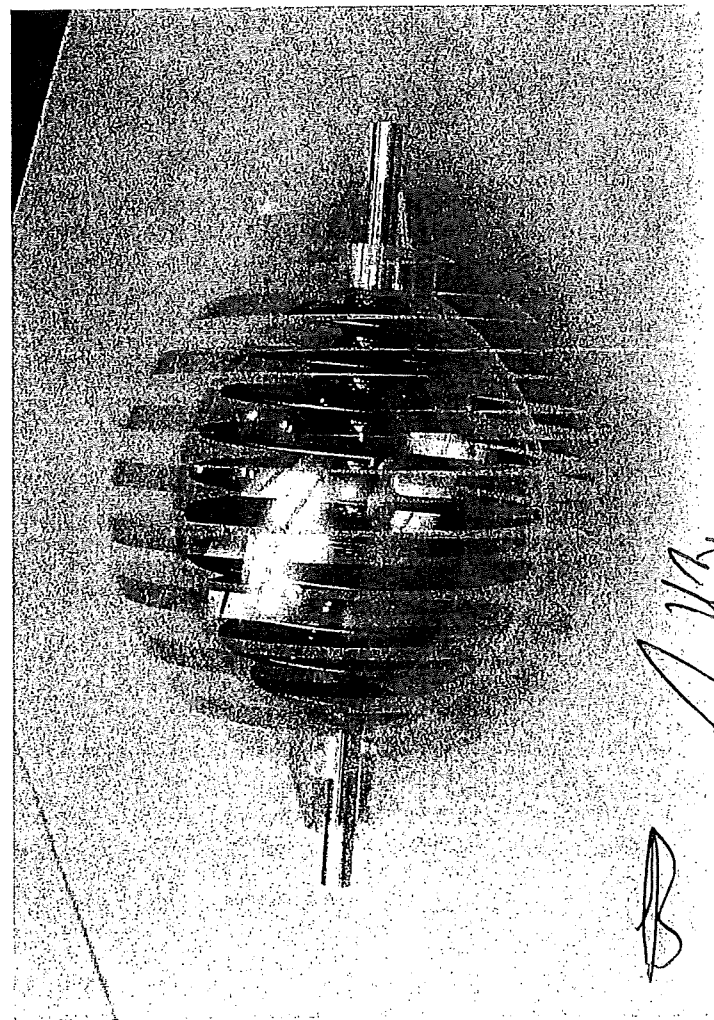
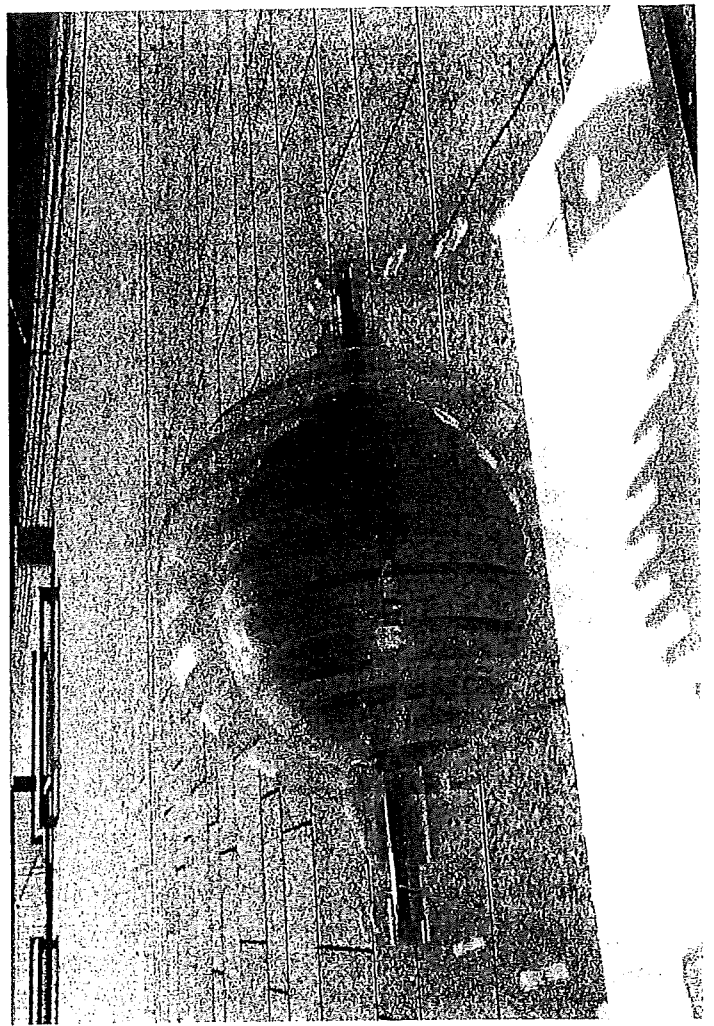
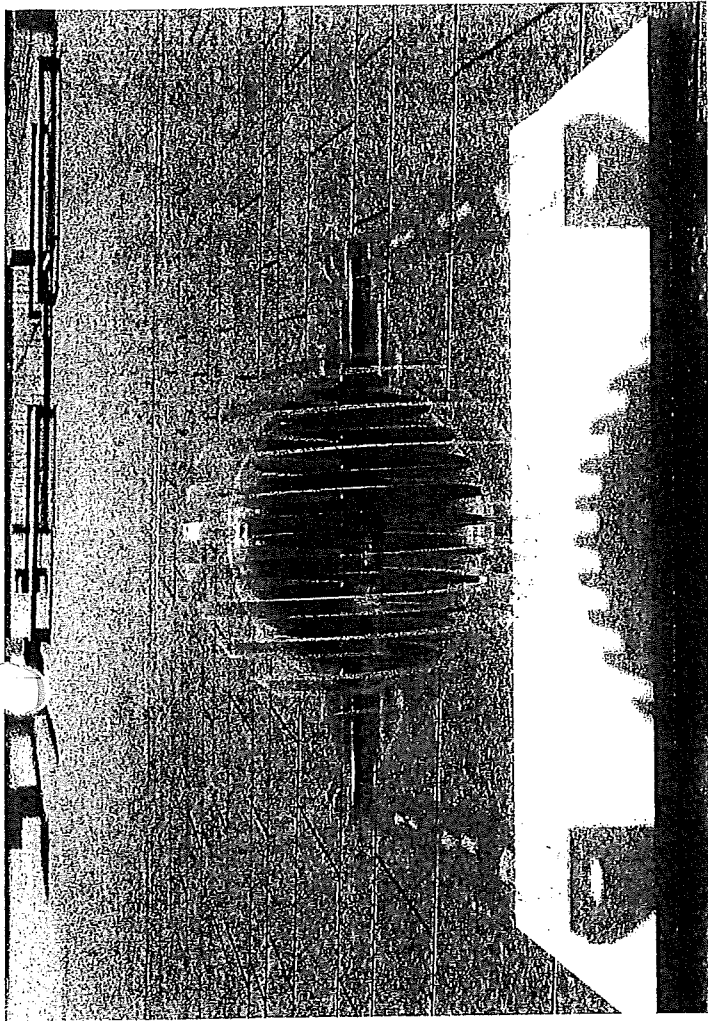

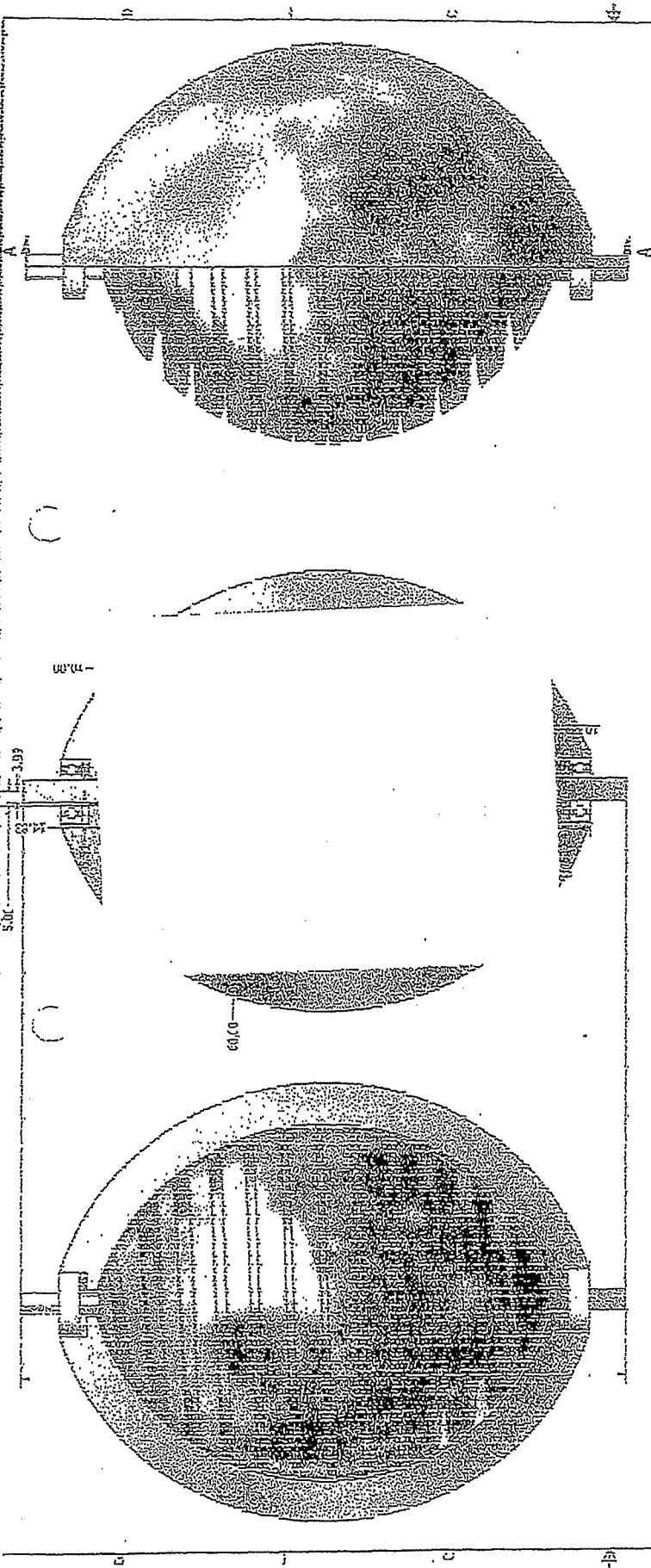

SECTION A-A
SCALE 1:1

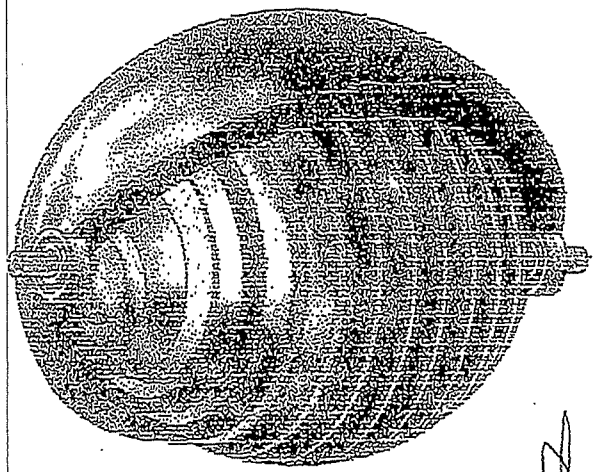

Handwritten signature or initials

Handwritten signature or initials

DESIGN	REVISED	TITLE	DATE
ASSEMBLY	ASSEMBLY	Antimony, B (Pilliant)	
SIZE	SCALE	PROJECT	SHEET 1 OF 1
C	1:1		

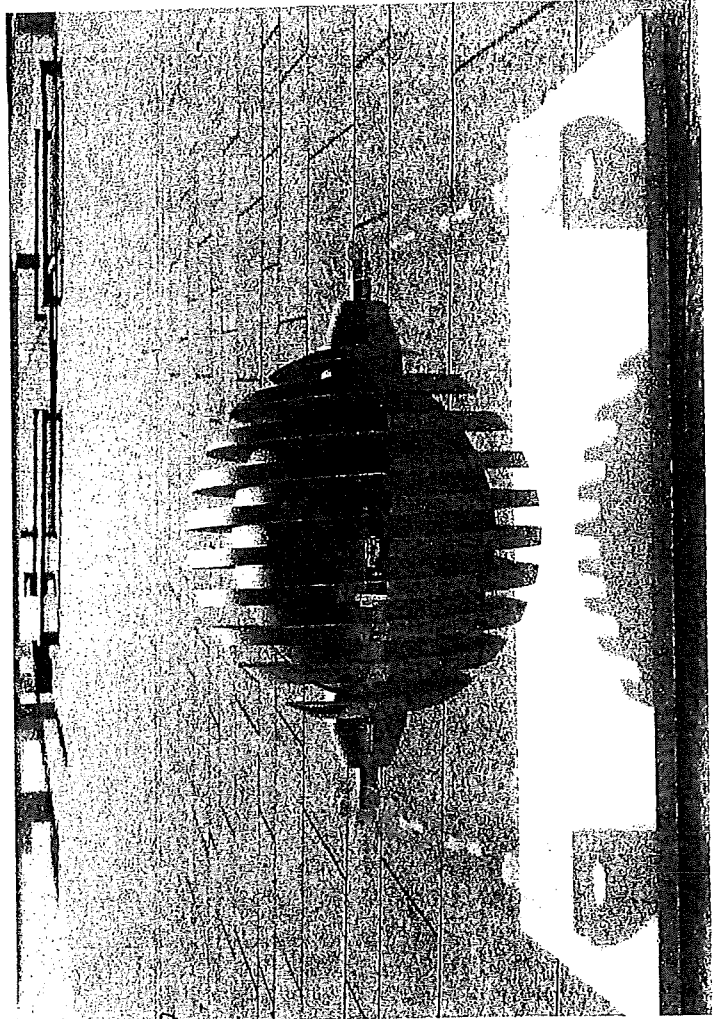
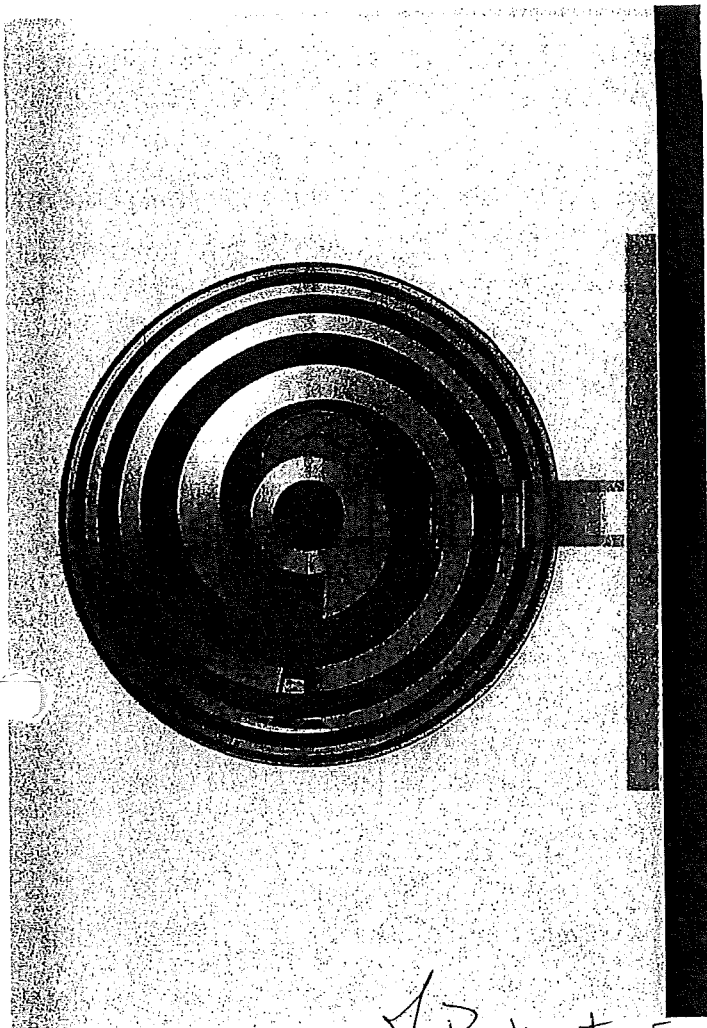

H. BAWANTYRE COPY RIGHT

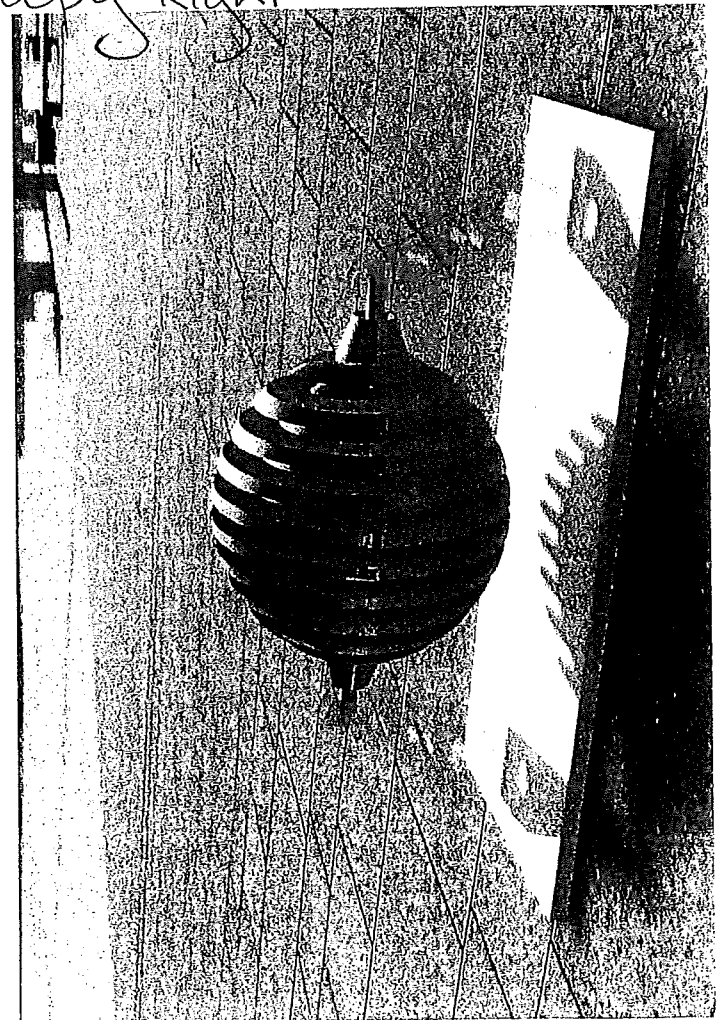
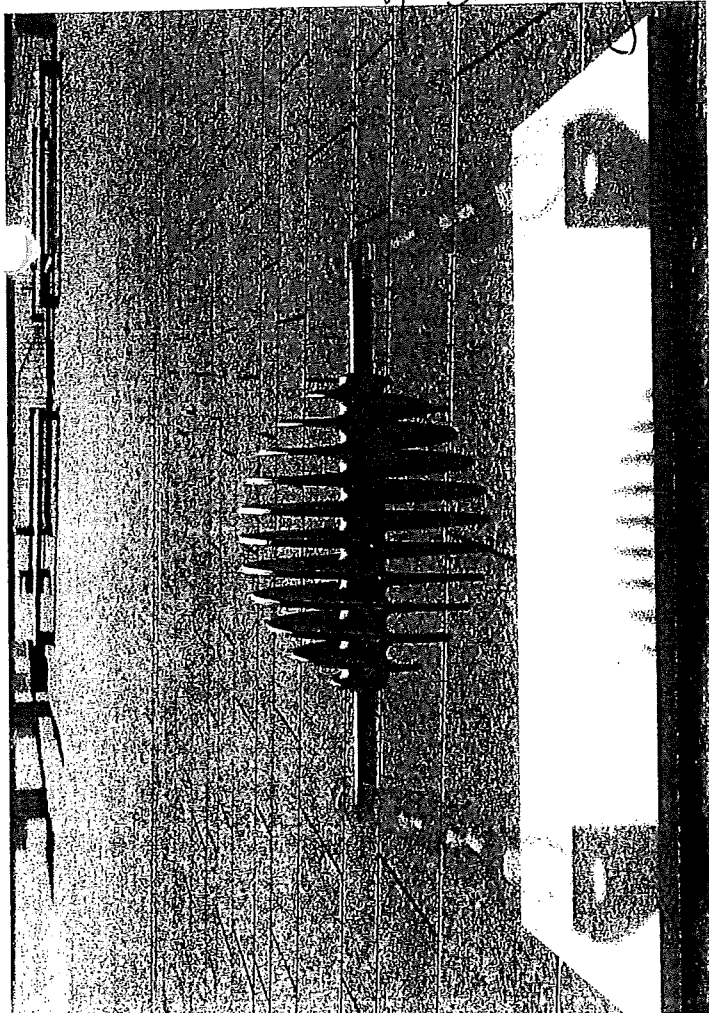

ANTONYM TECH

PCT/NZ2014/000051

The Means for Facilitating the Supply of Energy.

Stage (1) Free Kinetic Energy.

GLOBAL APPLICATIONS:

The Means for Facilitating an Electrical Mechanical Field.

Stage (2) Free Electrical Energy. NZ Patent Pending:

GLOBAL APPLICATIONS:

The Means For Facilitating the Division of Atoms and Molecules.

NZ Patent Pending

Applications: GLOBAL

Desalination, Blood Separator, Milk Separator, Water Purifier, Air Purifier, Lakes Rivers Harbour Restoration, Japan Nuclear Water Sanitizing. Waste water, Sewerage Treatment. Private & Commercial units etc.

The Means for Facilitating the Propulsion of Atoms and Molecules.

NZ Patent Pending

Applications: GLOBAL

Jet Engine Planes, Drones, Flying Cars, Boats Ferries (Transportation), Missiles, Space Travel, Sat aight recovery and Deployment, Deep water mining (Suction), Sprinkler systems, Water Blasters, Cutting Tool, Smoke Evacuator Buildings, Planes, ANTI Missile Protection system etc.

VERTICAL EARTH ANCOR Design:

SELF MOTION WATER PIPPING System:

"WASTE PLASTIC" BUILDING BLOCKS Design System:

INVENTOR: ANTHONY BALLANTYNE.

TRUE & NOT MISLEADING

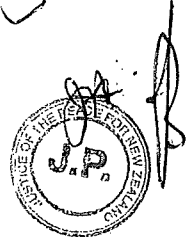

P.W. ATKINS

Physical Chemistry 2014

Owner: J. McFadden 45a Apirana Ave Glen Innes AK6 585-947

Page: (25)

Collision of Two Species sufficient energy to break & form bonds.

Page: (54)

Validation of the First Law (Thermodynamics) if it was to FAIL & the energy of a system increases! Without involving interaction of its surroundings it would BE POSSIBLE to construct a PERPETUAL MOTION MACHINE!

A CLOSED system may transfer energy to its surroundings, in doing so its energy is depleted! UNLESS that within that closed system the internal energy **IS INCREASING** (*Exponentially*) example! PCT/NZ 2014/000051 (The Means to Facilitate the Supply of Energy) INVENTION!!

Human/ Order to Chaos.

Nature/ Chaos to Order.

Human/ Balanced Forces * Equilibrium. i.e. Fossil Fuel Engine!

Nature/ Balanced "Opposing" Forces = Reciprocal Union * NON Equilibrium i. e. Cyclone!

Molecular Mass determents Molecular Speed.

Ironic Bonds (Electrostatic Interaction) allows for transfer of electron from one atom to another.

H₂O Bonds "Weak Van Der Waals Bonds" example $Na + Cl = Na^+$ plus Cl^- Covalent Bonds = H^- & Cl^- O^+ & Na^+ .

TITLE

Means for facilitating the supply of energy.

FIELD OF INVENTION

- 5 This invention relates to the supply of energy. A particularly preferred embodiment relates to the supply of energy using a fluid which moves generally in the manner of a vortex.

BACKGROUND

- 10 It is desirable that energy be provided in an efficient manner, and it is an object of a preferred form of the invention to go at least some way towards facilitating this. However the object of the invention generally is not so specific, and is simply to provide the public with a useful choice.

SUMMARY OF THE INVENTION

15 According one aspect of the invention there is provided means for facilitating the supply of energy, having:

- a first blade arrangement adapted to spin and provide an inner vortex path;
 - a second blade arrangement adapted to spin and provide an outer vortex path;
 - 20 • a fluid which is able to circulate between the vortex paths; and
 - means for extracting energy (eg a spinning shaft or shafts);
- characterised in that blades of each blade arrangement are configured to cause high pressure and low pressure regions within each vortex path to at least facilitate movement of the fluid through the vortex paths, and wherein the means for extracting
- 25 energy can extract energy from the moving fluid, directly or indirectly.

Preferably the first blade arrangement is adapted to spin in an opposite direction to the second blade arrangement so that the fluid can circulate between the two vortex paths.

- 30 Preferably the first and second blade arrangements are configured to spin about a common axis.

Preferably the first blade arrangement is generally spherical (eg spheroid or an elliptical sphere).

35



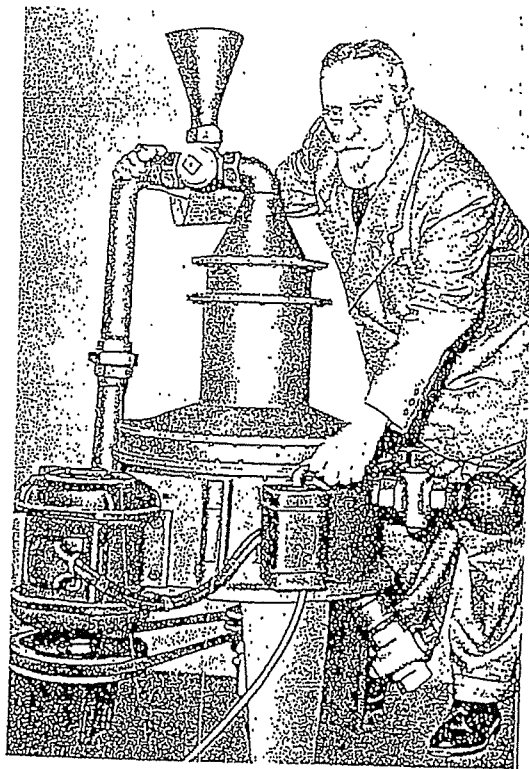

Fig. 1.3a The Home Power Generator.



Fig. 1.3b

My Inspiration : Book.
 LIVING WATER'S
 By: Cullum Coats
 RE: VIKTOR SCHAUßBERGER

RIGHT TO COMPLAIN TO THE MEDIA!

Ref: The New Zealand. **BILL OF RIGHTS ACT 1990.**

Re: Page (78). *Right to Complain to the Media.*

NEWS MEDIA & PRIVACY ACT 1993.

Effectively: *Media Exempt.*

Legal Precedent.

Ref: Talley Family V National Business Review (1997) 4 HRNZ (CRT)
Covers anything related to News, Observation or Current Affairs (s2).

BREAKING NEWS!!

NEW GREEN ENERGY TECHNOLOGY INVENTION
(SUPPRESSED) INVENTOR FRAMED FOR
MURDER!!!

16A

28

E Prisoner SHCF

From: Ross Hyland <ross@rosshyland.co.nz> ← **COMPROMISED**
 Sent: 24 July 2016 10:27 a.m.
 To: E Prisoner SHCF
 Subject: FW: Anthony Ballantyne PRN 42581582

Dear Tony

Great to hear from you and irrespective of the terrible position you find yourself in, good luck with all your endeavours to clear your name. Just a point to note your letter turned up Friday (July 22nd) and yet I note you wrote it on the 10th of June. Clearly the prison mail system works at its own pace. I certainly hope this email gets to you quickly and finds you safe and well.

~~Previously, what occurred was a very big shock to everyone and especially my University of Auckland colleagues~~
 I am simply cannot be linked in any way with such a horrible situation. As such I have had to maintain a wait and see approach with respect to your energy technologies and I have been waiting for the dust to settle. I am delighted you are back thinking about next steps for ~~the energy technology~~ however I can only really help if we can agree on some kind of acceptable pathway and funding mechanism that will allow the right ownership structures to enable us to firstly progress a technically sound validation methodology and then subsequently a development pathway.

I can certainly follow up with the UoA team, however I can tell you, that you will not get a reply from any of the staff should you write directly. They simply will not get involved at this juncture, so please understand whilst you are in your current predicament, such non response is just reality. Please don't take offence, I am just telling you as it is.

I will check out how to go about arranging a visit with you to have a catch up face to face? I believe this would be the most useful way and we can at least simply chew the fat around next steps and whether you would like my on-going assistance. I will call into the local corrections facility in Ulster Street to check out the procedure.

Finally, I am currently building a new boat, a Maritimo 48 fisher. Its 52 foot and about the same size as my old one (sold my old one a couple of months ago) so when you get out we can head off and catch some great snapper and akihi at Whanga. Who knows we may be able to also get a cray or two.

Good luck with all your travails, it's certainly a path that nobody would have wished upon you.

Kind Regards
 Ross Hyland
 Hamilton

~~PATENT PUBLISHED IN GENEVA DATE (2-10-14)~~

~~PEER REVIEWED~~: RETURN ON SCIENCE DIV: ALL (28-10-14)

Rejected offer From General Electric: 1-5 B:

GREEN ENERGY INVENTION: AUTHENTICATED. CONCEPT
 VALIDATED AND GLOBAL APPLICATIONS

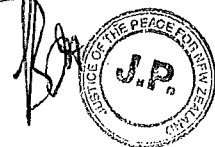

7th July. 2022.

To: **The Prim Minster of Australia.**

Mr. Anthony Albanese.

c/o The Australian Consulate General Office NZ : Auckland Office. PriceWaterhouseCooper Towers.

Dear Sir: Anthony.

My Name is Anthony Ballantyne, born in Footscray, Victoria, Melbourne Australia Date: 19th March. 1953.

With respect Sir: I am a Proven Inventor, & to date my Green Kinetic Energy Technology is the most important invention yet invented, in respect to Mitigating Climate Change & Australia's best hope of Stopping Wild Fires & Devastating Floods!

My Energy invention has the potential to REPLACE ALL previous form of existing energy (Fossil Fuels) in a peaceful transition over five to ten years with a number of my inventions capable of replacing known Jobs Example: (Fossil Fuel Industries) with World Wide Desalination Industries! Etc.

Sir, I beg Your Help!

Seven years four months past I was Framed for a murder that I did not commit by a number of persons, in order to steal my Technology, & Despite gathering enough evidence to prove my innocents my Appeal was unlawfully blocked, but through dogged determination & additional Fresh evidence my case has been excepted by the NZ Criminal Cases Review Commission No 0198 & Now up graded to the Pre Investigative (Triage) stage.

Note: The Auckland Consulate Office has copies of All my Documents but are unable to help me as they are not able to interfere with-in another countries Judicial System But With Respect Sir: You Do!

Sir, It is my intention to set up a Consortium of Countries lead by the USA with Australia's involvement to own, control, and administer the fair distribution & Licencing of my Technology to the World.

To also include Russia & China with-in this consortium so that they have an incentive to stay peacefully and in harmony with the rest of our world & Hopefully get Russia to STOP its war on Ukraine each country will sub licence this technology to their own citizens to maintain a Tax structure which will enable them to maintain schools, Hospitals, Dental, & Critical Infrastructure and reduce dep't.... long into the Future.

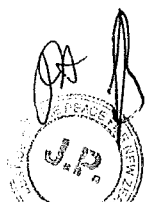

I have also developed a new Propulsion technology (Data Proven) which will revolutionise our transport industries, greatly reducing transport costs worldwide & in return will mean more money in peoples pockets not to mention a world free of Polluting Fossil Fuels Clean Air & Water, also part of my propulsion technology can be adapted to a fully autonomous missile system, (used for good) its capabilities include the ability to stay in the atmosphere over a number of counties (North Korea) to intercept any & all threats that may happen in the future, retrieve & clean up old satellites in space and to act to a deterrent to any country that threatens world stability by taking out GPS satellites etc.

Australia, New Zealand, & or the USA can act as a party in this respect to ensure the safety of our world.

I have also developed a new Desalination system which enables a cheaper easier means of procuring fresh water from the sea, which in the future will enable arid deserts to become green again in turn helping the worlds eight billion population to benefit from new fertile lands.

Anthony Sir, with Respect I cannot do this alone & NOT From with-in HELL!

Kind Regards

Sincerely Yours

Anthony (Tony) Ballantyne.

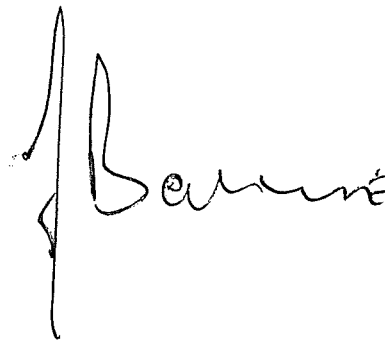
A handwritten signature in black ink, appearing to read 'Anthony Ballantyne', written in a cursive style.

James and Well
Level 12 KPMG Centre
85 Alexandra St
Hamilton.

22. 5. 2019

Attention: Mr. Jason Tuck. Ref: 302574/73
And To: Mr. Ceri Wells

Attached: Signed Authorisation Form.

Note: Mrs. E. J. Ballantyne (Joy) 078434304. Can Confirm that my Property at Whangamata (Dept. Free) is on the Market to raise funds for a Honest QC For my Appeal.

Note: Mr. & Mrs. Sturt and Maylene Ross 078436304. E-Mail home@rossaccounting.co.nz

Note: Mr. Rajendra Manahan (Raj) C/O Bill West 078544031. E-Mail bwest.ltd@gmail.com
Can both either arrange for interim funds or Grantee's to assist in Funding.

Note: Copy of E-Mail Date (24. 7. 2016) Mr. (Ross) Hyland.

Ref: Energy Technology, Mr. Camden (Ross) Hyland. is the Chair Person of the Return on Science Division of the A. U. (As Personally Recommended by Ceri Wells) my Energy Invention Technology was "PEER Reviewed" by the Return on Science Division and The A. U. Engineering Faculty Date (28. 10. 2014) VALIDATED as being Authentic and having Global applications.

At the end of that meeting Mr. Ross Hyland made an offer to me on the Behalf of General Electric for one point Five Billion Dollars, Which was Rejected, as only Stage one was disclosed at that time and I was still working on Stage three.

I later learnt that they wrongly assumed that I was just a back yard No 8 (Hick) NZ inventor that had No real Knowledge as to what I had invented and its Full Potential.

Mr. Bill West is in Possession of the Following:

1. Additional Merit: Re: The Means To Facilitating the Supply of Energy(Kinetic) Stage One. Page 5. Of 5. And a USB stick Re: (Animation Video) Re: Analytical workings and The Physics Formula to my Energy Technology.
2. Patent Pending: The Means To Facilitating an Electro- Magnetic Field (Stage Two).
3. Patent Pending: The Means To Facilitating The ~~Discovery~~ of Atoms And Molecules.
4. Patent Pending: The Means To facilitating The ~~Discovery~~ Of Atoms.

Note: Copy of (1) and (2) Attached.

Note: It is Urgent that the above Patents Pending Applications are Submitted A. S. A. P. Stage Three will be Discussed with you on my Release!!

I Have Written to you and the Patents Office on a number of occasions Stating that I was framed For Murder (Motive) Theft of My Intellectual Property (Suppressed).

M. W. W. 

Attached is an E-Mail Dated (13. 5. 2019) To: The Independent Police Conduct Authority,
And The Legal Services Commission. Date (20. 5. 2019) With DNA Evidence of Innocents and
Collusion by a number of persons (Perjury) Etc..

Mr. Bill West is 81 years of age and his fifty foot fall down the bank of the Waikato River has
greatly affected Bills Ability to Support me.
If You or Ceri Know of a "Honest" QC please contact them on my Behalf, as I have been
fighting for the Truth for close to four and a Half years now!! and have been forced to
contact Media in both NZ and Australia so it is Vitally Important the Those above Patents
Applications Are processed as soon as Possible for both my Safety and Protection: Thank
You I Look Forward to Discussing with you and Ceri, how to proceed further with the many
applications resulting from my Technology

Sincerely Yours

Anthony Ballantyne.

Waikeria Prison
MIRO Unit.

Ballantyne
[Signature]
[Signature]
[Signature]
FR.
2019
July

Michael A.H. Williams, JP
#95175
TE AWAMUTU
Justice of the Peace for New Zealand

B

PEOPLE, GROUPS That care about Climate Change:

Antonio Guterres: UN SECRETARY GENERAL

John Kerry: USA CLIMATE ENVORY

Alok Shama: C.O.P. 26 PRESEDENT

Amal Clooney: H/R LAWYER: SPEAKER C.O.P.26

Sonam P. Wangdi: LEADER 47 POOR COUNTRIES

Lord: Zak Goldsmith: SPEAKER C.O.P. 26

David Tong: OIL CHANGE INTERNATIONAL

Dr. Luke Harrington: CLIMATE RESERCHER

Niklas Holme: CLIMATE SCIENTIST

Tim Nash: NZ CLIMATE SCIENTIST

Peter Erickson: CLIMATE SCIENTIST

Mary Robinson: EX IRISH PRESEDENT (ELDERS GROUP)

CLEAN CREATIVES: GROUP CLIMATE LOBYISTS

Jennifer Morgan: EXECUTIVE GREEN PEACE

Barack Obama: EX USA PRESEDENT

Greta Gunburge: CLIMATE ACTIVIST

Sykuro Manabe: CLIMATE ACTIVIST

Sir. David Attinborough: TV PRESENTOR

Cindy Baxter: COAL ACT NETWORK

Profesor. Steven Ratuaa: F.R.S.N.Z

Angela Merkle: EX CHANSLER GERMANY

James Shaw: NZ CLIMATE MINISTER

Isabell Ewing: CLIMAT CHANGE JOURNALIST TV 3

10139

N.Z. POLICE

Police 29
11/97

J O B S H E E T

Due _____
File _____

OFFENCE: OPERATION TIGER

INVENTION

DATE and TIME	First plan your inquiry then set out the action taken, inquiries made, oral statements of persons seen and information gained, etc.
---------------	---

12/02/2015 Operation Tiger.

Directive 101

1153 hours Contact by phone:

HYLAND / Camden / Ross (known as Ross)

DOB: 30/09/1954

Ph:

Speak with HYLAND.

He advises that he has a boat moored at the Whangamata marina. That berth was hired from E26 Berth Limited. This company is owned by Tony BALLANTYNE and another person who he is unsure of the name, who he believed was a Fijian Indian. (Rajendra MONOHAN)

He first saw the berth for sale on Trade Me in October 2014. He made contact with the person and this was Tony BALLANTYNE.

At that time he had his boat at the Westhaven Marina and he had been considering moving it to Whangamata.

Originally he was unable to hire the berth as the company had been de-listed. In the end Tony had to get hold of his accountant (whose name he could not recall) as the company had been de-registered and it took some days for that company to be re-registered.

He signed a 3-year lease for the berth. He paid \$12,000 for the 3years.

The Marina Society was owed about (he thought) \$4,500 in regards to outstanding arrears.

He paid the arrears to the Marina Society and the remainder into Tony BALLANTYNE's account.

He did not know Tony BALLANTYNE prior to this.

Name: Steven WILSON

Checked by: _____

J O B S H E E T

Due _____

File _____

OFFENCE: OPERATION TIGER

DATE and
TIME

First plan your inquiry then set out the action taken, inquiries made, oral statements of persons seen and information gained, etc.

He's probably had about five or six meetings with him since.

He met with him at his house in Whangamata after the advert.

He describes him as being an intriguing individual.

He took him on his boat in about January of this year when they were staying over at Whangamata. He had also been to his house in Whangamata on another occasion and he believed that Tony had been to his house in Pollock Drive, Hamilton, on one occasion.

He was aware that Tony had some invention.

HYLAND is on a panel in Auckland University. This panel had some involvement in things such as what Tony had "invented". He also has an involvement with the Callaghan Institute, a government funded body named after Sir Paul Callaghan which promotes such things and has a pool for funding (in very simplistic terms).

He took him to Auckland University to meet some people, such as those involved in physics and other things in order for them to look at the invention, but believed that it was likely that that would require approximately \$250,000 to \$500,000 for the invention to be furthered. That is where the "invention" and his involvement ended up to this point.

He advised his email address is ross@rosshyland.co.nz

I advise him that I will send him an email in regards to some documents he may have in terms of renting the berth.

Name: Steven WILSON



Checked by:

**PEOPLE, GROUPS That care about Climate Change: THAT CAN HELP ME!!!!
HELP OUR WORLD**

Antonio Guterres: UN SECRETARY GENERAL. John Kerry: USA CLIMATE ENVORY.
Alok Shama: C.O.P. 26 PRESEDENT. Amal Clooney: H/R LAWYER: SPEAKER C.O.P.26.
Sonam P. Wangdi: LEADER 47 POOR COUNTRIES. Lord: Zak Goldsmith: SPEAKER C.O.P. 26.
David Tong: OIL CHANGE INTERNATIONAL. Dr. Luke Harrington: CLIMATE RESERCHER.
Niklas Holme: CLIMATE SCIENTIST. Tim Nash: NZ CLIMATE SCIENTIST.
Peter Erickson: CLIMATE SCIENTIST. Mary Robinson: EX IRISH PRESEDENT (ELDERS GROUP)
CLEAN CREATIVES GROUP, CLIMATE LOBYISTS. Jennifer Morgan: EXECUTIVE GREEN PEACE.
Barack Obama: EX USA PRESEDENT. Greta Gunburge: CLIMATE ACTIVIST.
Sykuro Manabe: CLIMATE ACTIVIST. Sir. David Attinborough: TV PRESENTOR.
Cindy Baxter: COAL ACT NETWORK. Professor. Steven Ratuaa: F:R.S.N.Z.
Angela Merkle: EX CHANSLER GERMANY. James Shaw: NZ CLIMATE MINISTER.
Isabell Ewing: CLIMAT CHANGE JOURNALIST TV 3. Price Charles: FOUNDATION.
The NZ OMBUDSMAN. The NZ HUMAN RIGHTS COMMISIONER.
The SUN NEWSPAPER England. INFO WARS Web Site:
NEW@NZME.CO.NZ NEWS@STUFF.CO.NZ
TV ONE Breakfast. TV THREE Breakfast.
Sunday@tv.co.nz Program. BBC.
ABC. CNN.
FOX NEWS. CBS.
The SYDNEY MORNING HERALD. TV NINE Australia.
TV SEVEN Australia. The NZ ACT Party David Seymour.
NZ FIRST Sir Winston Peters. Price Williams EARTH SHOT PRISE .
James & Wells Patent Attorney. Price Harry & Megan.

T.V Program -
Awesome Planet

Al Gore

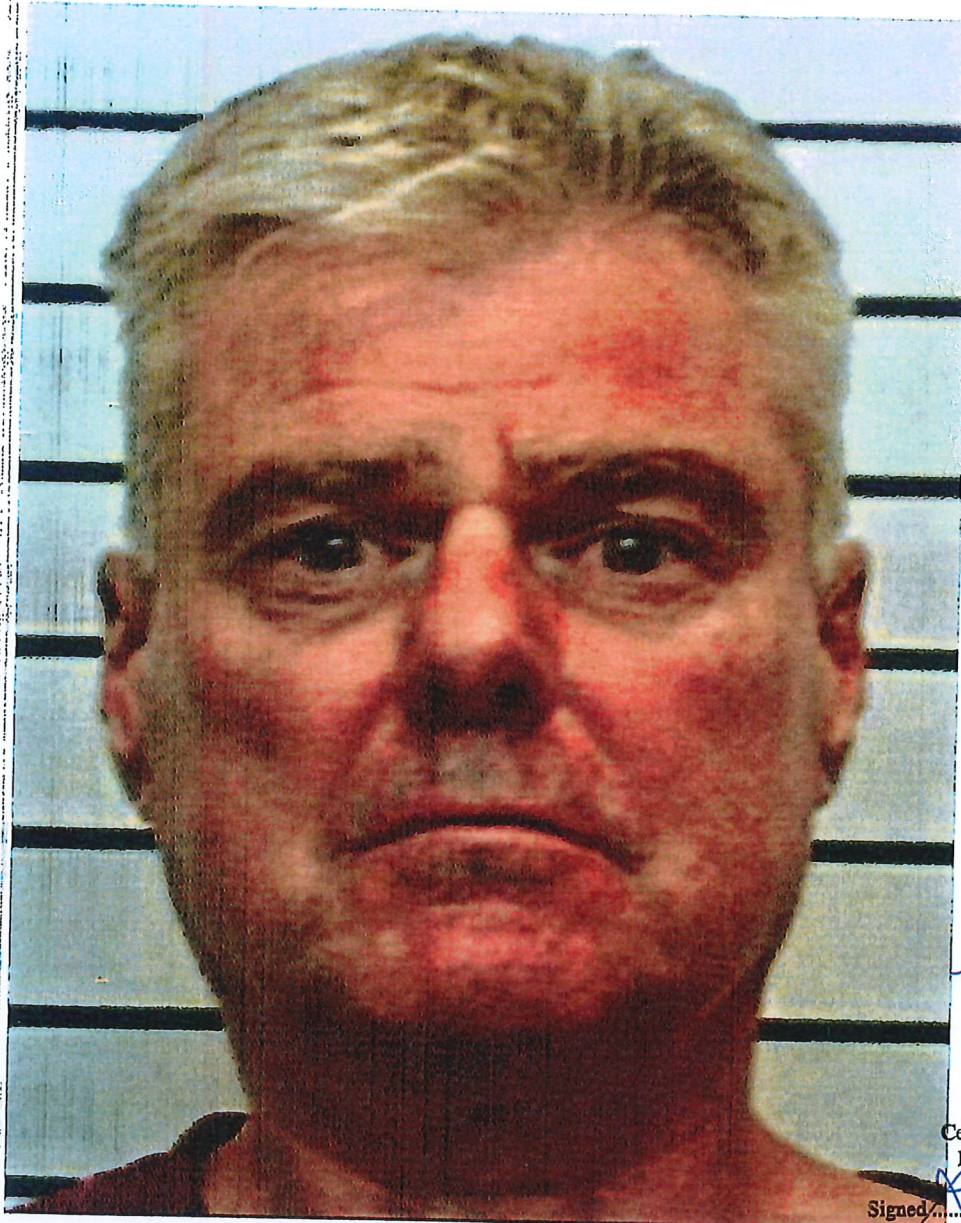

*This is a true Likeness
of Anthony Ballagtyr
AMR.*

Certified true copy of a document
presented to me as an original

Signed *Ann Rawson JP.*
Date *17 November 2021.*

Ann Marie Rawson, JP
#91060
TE AWAMUTU
Justice of the Peace for New Zealand

Daniel Taylor *165*
PCO
WAIKERIA *589*

30.9.21